

# SLAT WALL

**BE-1623R**

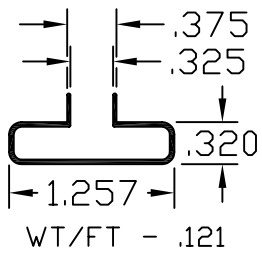

**BE-1867R**

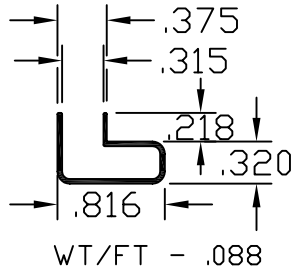

**BE-1966**

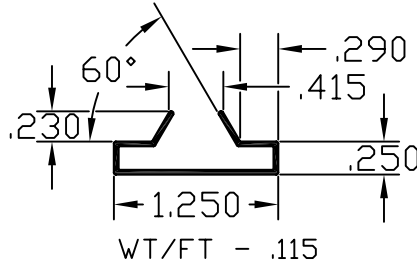

**BE-2135**

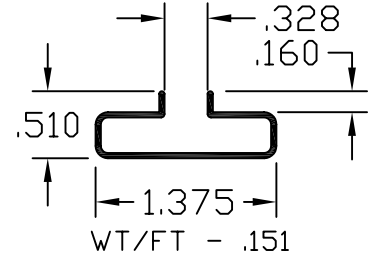

**BE-2141**

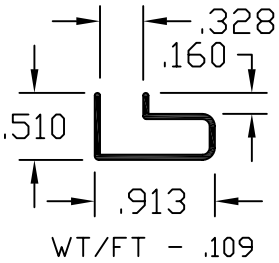

**BE-2358**

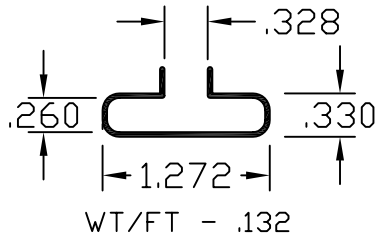

**BE-2569**

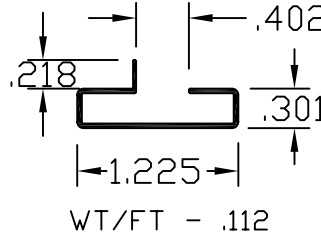

**BE-2578**

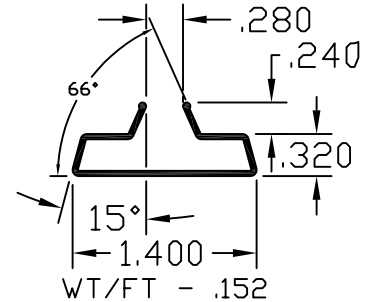

**BE-2859**

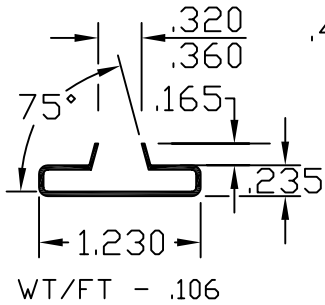

**BE-2903**

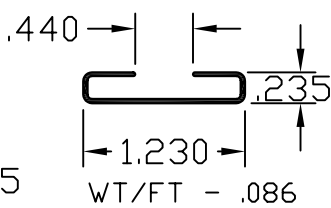

**BE-3028**

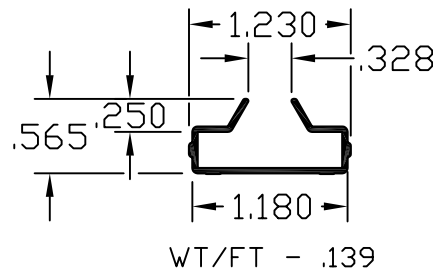

**BE-3169R**

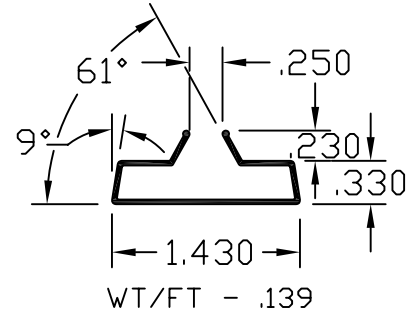

**BE-3226**

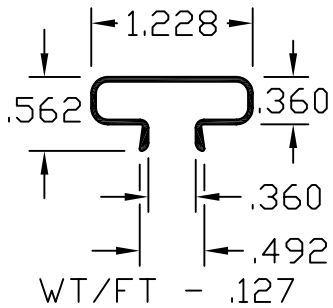

**BE-3238**

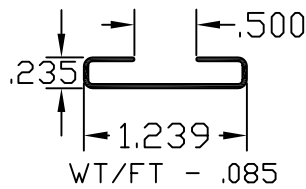

**BE-3840**

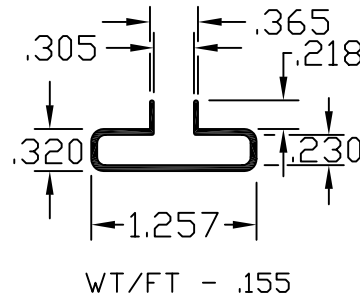

**BE-4078**

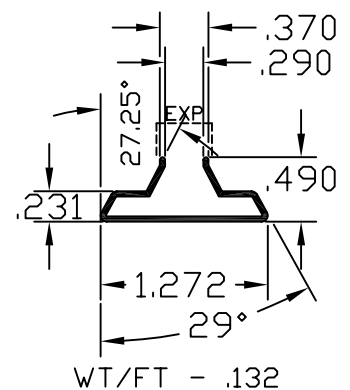

**BE-4555**

